



PENDLETON

FAMILY BRANDS

PRODUCT CATALOG



PENDLETON™
VALUABLES MANAGEMENT



REVOLUTION®
SAFE COMPANY

INSPIRED BY PENDLETON



REVOLUTION
TARGETS BY PENDLETON





PENDLETON SAFES

- 4 - 5 LEVELS
- 6 - 9 KING SERIES SAFES
- 10 - 13 KNIGHT SERIES SAFES
- 14 - 15 MATCHED PAIR
- 16 - 19 BISHOP SERIES SAFES
- 20 - 21 CONFIGURATIONS
- 22 - 23 TAC-75
- 24 COLLECTOR'S CONFIGURATION
- 25 DISPLAY STANDS
- 26 - 27 SECURITY AND FEATURES



REVOLUTION SAFES

- 28 - 29 REVOLUTION TECHNOLOGY
- 30 STRONGHOLD XL
- 31 STRONGHOLD XL RESERVE EDITION
- 32 STRONGHOLD XL TACTICAL EDITION
- 33 STRONGHOLD XL CUSTOM EDITION



REVOLUTION TARGETS

- 34 - 35 HEAVY DUTY TARGETS
- 36 - 37 PORTABLE TARGETS
- 38 - 39 COMPACT TARGETS



CUSTOM BUILT FOR YOUR COLLECTION.
PROUDLY MADE IN THE USA.

REFINED FOR ANY ROOM

HIGH-GLOSS FINISHES

Every Pendleton safe can be custom built with any of the colors listed on page 5. We also match any reproducible color in high-gloss finishes. Our high-gloss finish is a five day process that consists of a base and clear coat PPG automobile show car finish that is wet sanded and buffed with 1000 to 3000 grit sandpaper for a mirror reflection.

As a World & National champion competitive shooter, my firearms are my most valuable assets. I needed to keep them secure in a safe I could trust. That's why I called Pendleton Safes, and they built me a custom luxury safe for my most prized possessions. I put my guns and my trust in Pendleton Safes!

Jessie Harrison
World Champion Pistol Shooter



STEP ONE - CHOOSE A LEVEL

Levels are available in Bishop, Knight, or King Series. Each level features a unique look and feel with the same Pendleton standard of quality and security.



ANTIQUE COPPER TEXTURE

LEVEL 1

Includes revolving inner shelving, automatic lighting, and moisture control.



BLACK TEXTURE

LEVEL 2

Adds bright white interior, revolving outer shelf, and motorized rotation.

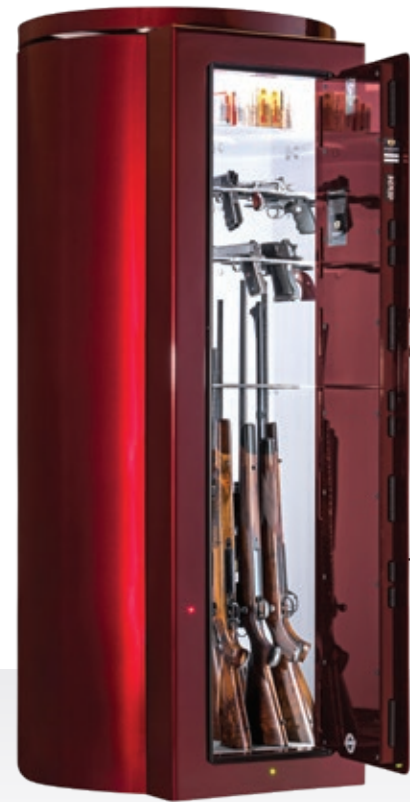

BURGUNDY GLOSS

LEVEL 3

Adds "show car" quality automotive PPG paint finish.

ORDERING PROCESS

- STEP ONE**
Pick your level. **SAME QUALITY, DIFFERENT APPEARANCE.**
- STEP TWO**
Pick your Series. **KING KNIGHT BISHOP**
- STEP THREE**
Place deposit to schedule production.
- STEP FOUR**
Configure your safe. You can pick from available configuration layouts. See pages 20-24 for examples. **OR** take advantage of the specialized configuration service included with all orders. Send us basic information and we will maximize the design.
- STEP FIVE**
Make it yours. Personalized logo? Custom appearance? Other?

FEATURE TABLE

| EXTERIOR FINISH | TEXTURED | TEXTURED | HIGH-GLOSS |
|------------------------------|----------|--------------|--------------|
| INTERIOR FINISH | TEXTURED | BRIGHT WHITE | BRIGHT WHITE |
| REVOLVING OUTER SHELF | — | ✓ | ✓ |
| MOTORIZED ROTATION | — | ✓ | ✓ |
| BRIGHT WHITE SHELVING | ✓ | ✓ | ✓ |
| CUSTOM SHELVING | ✓ | ✓ | ✓ |
| INTERIOR LED LIGHTS | ✓ | ✓ | ✓ |
| MOISTURE CONTROL | ✓ | ✓ | ✓ |
| GLOSS BLACK ACCENTS | ✓ | ✓ | ✓ |
| CHROME ACCENTS | OPTIONAL | OPTIONAL | OPTIONAL |
| ELECTRONIC KEYPAD | ✓ | ✓ | ✓ |
| MOISTURE AND LOCK INDICATORS | ✓ | ✓ | ✓ |

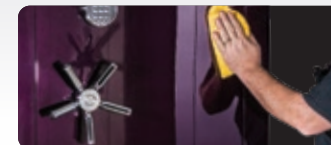

HIGH-GLOSS FINISHES

Level 3 safes shine with a PPG automobile show car finish that is wet sanded and buffed for a mirror reflection.



REVOLVING OUTER SHELF

Level 2 and 3 safes feature a revolving external shelf for storing calls, ammo and other gear.

SCRATCH-RESISTANT TEXTURED FINISHES



MIRROR-REFLECTIVE GLOSS FINISHES

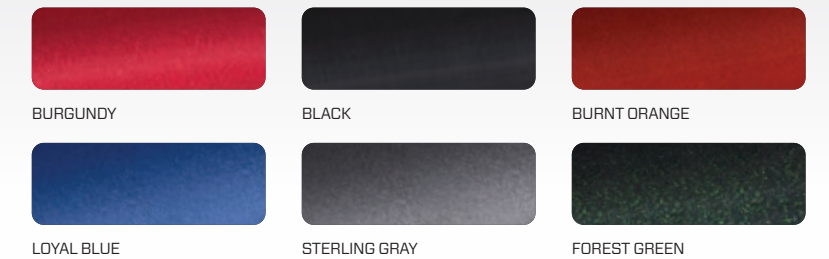

Pendleton matches any reproducible color in optional high-gloss premium finishes.



Built for the collector who demands the highest security, King Series Safes come standard with a 1/4" thick steel exterior, 100% fully-welded seams and feature a compact door frame design that fits anywhere in the room, including corners and tight spaces.

DESERT STONE TEXTURE



CUSTOM SILVER GLOSS
Shown with optional features

BURGUNDY GLOSS
Shown with optional features

HIGHEST SECURITY LEVEL

DIMENSIONS

HEIGHT: **75"**
WIDTH: **32.25"**
FRONT WIDTH: **21"**
DEPTH: **35.5"**
WEIGHT: **1250 LBS.***

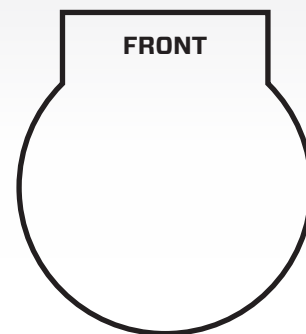

* Weight varies based on shelving configuration and options.



BLACK TEXTURE

KEY FEATURES



COMPACT DOOR FRAME

Featured exclusively on the King Series, the compact door frame allows the safe to comfortably fit anywhere in the room.



PATENTED HANDGUN STORAGE

Pendleton's innovative handgun shelving comfortably stores up to 17 handguns per half shelf. Available with alternating large / small cutaways for handguns of varying size.

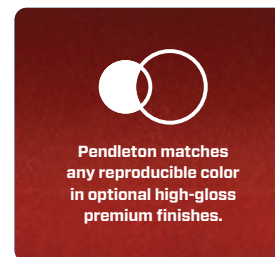

YOUR CHOICE OF FINISH

Scratch-resistant textured finishes are featured on level 1 and 2 safes. Level 3 safes offer premium high-gloss finishes.



COLORS AND FINISHES

The King Series by Pendleton offers a wide variety of both textured and high-gloss finishes as determined by your choice of level (described on pages 4 and 5). Custom high-gloss colors are also available. Accents are offered in black with an optional chrome package upgrade. Several samples are shown below with optional features.



Pendleton matches any reproducible color in optional high-gloss premium finishes.



BURGUNDY GLOSS



CUSTOM SILVER GLOSS



CUSTOM PEARL WHITE GLOSS



FOREST GREEN GLOSS



DESERT STONE TEXTURE



BLACK TEXTURE

Knight Series Safes offer unprecedented storage capacity in a compact footprint, making it easier than ever to protect and manage extensive and varied collections. Pendleton™ Knight Series Safes incorporate a solid steel exterior of 3/16" minimum thickness, plus an 11/16" reinforced door frame with a 2" structural striker for rigidity.

The Knight's wide-access door provides more visibility, fast and easy access, and includes corner shelving for convenient handgun or accessory storage.

WHITE LINEN TEXTURE



BLACK TEXTURE
Shown with optional features

ULTIMATE STORAGE CAPACITY

DIMENSIONS

HEIGHT: **75"**
WIDTH: **32.25"**
DEPTH: **35.5"**
WEIGHT: **1200 LBS.***

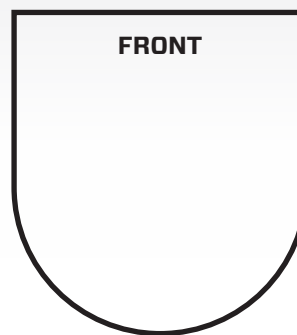

* Weight varies based on shelving configuration and options.



BURGUNDY GLOSS
Shown with optional features

1/4" STEEL UPGRADE AVAILABLE

KEY FEATURES



CORNER HANDGUN SHELVING

Not your typical door-attached handgun bags – The Knight Series by Pendleton offers unique corner handgun shelving for fast and easy access with unprecedented visibility.



OPTIONAL CORNER STORAGE SHELVING

Providing over 10 feet of storage for ammo and other accessories.



ORGANIZE YOUR INVENTORY

Pendleton's option for custom numbered shelving makes it fast and easy to identify your guns.

COLORS AND FINISHES

The Knight Series by Pendleton offers a wide variety of both textured and high-gloss finishes as determined by your choice of level (described on pages 4 and 5). Custom high-gloss colors are also available. Accents are offered in black with an optional chrome package upgrade. Several samples are shown below with optional features.



Pendleton matches any reproducible color in optional high-gloss premium finishes.



CUSTOM SILVER GLOSS



CUSTOM AMETHYST GLOSS



CUSTOM GOLD GLOSS



BLACK GLOSS



WHITE LINEN TEXTURE



ANTIQUE COPPER TEXTURE

**MATCHED
PAIR**

ORDER FACTORY DIRECT

www.PendletonSafes.com or 770-466-6181

MATCHED PAIR
A PERFECT MATCH



BURNT ORANGE GLOSS
Shown with optional features

MAKE IT A PAIR

A PERFECT MATCH

Take your existing Knight Series safe and make it a matched pair. Whether you want to add to your firearms collection, store jewelry and valuables, or do a little of both – a matched pair safe is the perfect complement to your existing Pendleton or management solution for your extensive collection. Opposing doors open from the center, so they never touch. You'll enjoy full access to both units – putting your entire collection at your fingertips.



LOYAL BLUE GLOSS
Shown with optional features



The Bishop Series offers remarkable storage efficiency and reduced overall height, making it perfect for smaller areas or people who prefer a lower profile. Its wide-access door and corner storage shelving make organizing and accessing your collection easier than ever.

CUSTOM PEARL WHITE GLOSS
Shown with optional features



CUSTOM AMETHYST GLOSS
Shown with optional features

EFFICIENT COMPACT DESIGN

DIMENSIONS

HEIGHT: **67"**
WIDTH: **32.25"**
DEPTH: **35.5"**
WEIGHT: **950 LBS.***

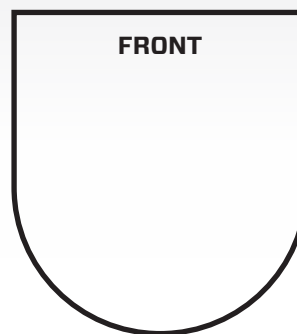

* Weight varies based on shelving configuration and options.



FOREST GREEN GLOSS
Shown with optional features

FEATURES



STORAGE EFFICIENCY
Ideal for height restricted areas.



CORNER STORAGE SHELVING
Additional corner storage shelving on both front interior sides, providing over 10 feet of storage for ammo and other accessories.



YOUR CHOICE OF FINISH
Scratch-resistant textured finishes are featured on level 1 and 2 safes. Level 3 safes offer premium high-gloss finishes.

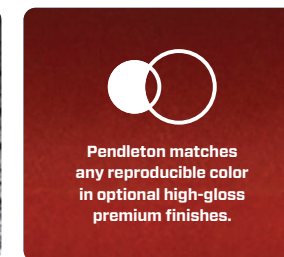

Pendleton matches any reproducible color in optional high-gloss premium finishes.

BISHOP

COLORS AND FINISHES

The Bishop Series by Pendleton offers a wide variety of both textured and high-gloss finishes as determined by your choice of level (described on pages 4 and 5). Custom high-gloss colors are also available. Accents are offered in black with an optional chrome package upgrade. Several samples are shown below with optional features.



Pendleton matches any reproducible color in optional high-gloss premium finishes.



FOREST GREEN GLOSS



CUSTOM AMETHYST GLOSS



CUSTOM PEARL WHITE GLOSS



BLACK GLOSS



ANTIQUE SUNRISE TEXTURE



BLACK TEXTURE

EFFICIENT SLENDER DESIGN

The Rook Series embodies the Pendleton reputation for remarkable storage capacity and industry leading ease of access. It features a narrow exterior width designed for passage through interior doors and smaller spaces along with a unique approach to organization allowing for big capacity from our smallest footprint.



WHITE LINEN TEXTURE

FEATURES



EFFICIENT LAYOUT

Rotate gun orientation to accommodate various guns without touching. No more bang scratches or dents.



COMFORTABLE FIT

Turrets match foam for easy alignment. Slide the gun stocks in and out for a comfortable fit.

DIMENSIONS

HEIGHT: **75"**

WIDTH: **29.75"**

DEPTH: **35"**

WEIGHT: **1000 LBS.***

* Weight varies based on shelving configuration and options.



FITS THROUGH STANDARD DOORS

At 29¾ inches wide, the Rook fits through standard 30 inch doorways.



TRADITIONAL LAYOUT

The traditional configuration is a perfect choice for most collections due to its ability to store over 90 handguns plus 40 shotguns or 30 scoped bolt action rifles. You can choose any combination of handgun or valuables storage shelving to customize it to your individual needs.



TAC-75 LAYOUT

TAC-75 has proven to be an excellent tactical firearm storage solution. With fully adjustable shelving, customize your TAC-75 safe interior to hold a vast array of tactical firearms, including .50 BMGs, SBRs and traditional rifles. See page 22 for a detailed look at the TAC-75 layout.



HANDGUN LAYOUT

Do you have an extensive and varied handgun collection? Pendleton can configure your safe to comfortably hold up to 300 handguns. We can also swap out handgun shelves with storage shelves for your important valuables.



COLLECTOR'S LAYOUT

Pendleton's combination shaft option allows for incredible storage versatility. Customize specifically for your collection. See page 24 for an example dedicated to jewelry and valuables storage.



TAC-75 LAYOUT UP CLOSE

ORDER FACTORY DIRECT

www.PendletonSafes.com or 770-466-6181

CONFIGURATION: TAC-75 LAYOUT
PURPOSE-BUILT STORAGE



OVERSIZED .50 BMGS? SUBCOMPACT SEMI-AUTOS? NO PROBLEM!



LOYAL BLUE GLOSS

FEATURES



BOTTOM ROW: ANY LENGTH GUN



LONG-GUN BARREL PORTS



TOP ROW: AR / SBR / BULLPUP



LARGE TRIANGLE PORTS



STERLING GRAY GLOSS Shown with optional features

GO CUSTOM

Customize the TAC-75 configuration around YOUR tactical collection. Available in King or Knight series safes.



CUSTOM CONFIGURATION



CUSTOM PEARL WHITE GLOSS
Shown with optional features

CUSTOM TAILORED FOR YOUR VALUABLES



JEWELRY AND OTHER COLLECTIONS



HALF SHELVING WITH GUARD



COMBINATION DISPLAY STAND

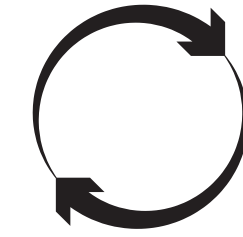

360° ROTATING GUN MANAGEMENT



LONG-GUN DISPLAY STAND

DISPLAY STANDS

Designed for walk-in vault rooms, these ultra-sturdy, free-standing displays are custom-configured to suit your needs. Pendleton Revolution Technology® enables the entire system to rotate 360° for easy access to all guns, while the exclusive circular turret design displays up to 40 scoped long-guns side-by-side without touching.

- Custom built for your needs
- Can be configured to hold 250 handguns
- Fast and easy access

SECURITY AND FEATURES

It's what's inside a Pendleton Safe that places it among the finest in the industry when it comes to theft prevention and security. The following features operate behind the scenes to help fortify your valuables in the event of an attempted break-in.

STRICTER TOLERANCES / PRECISION-ENGINEERED

Pendleton doesn't cut corners. We use leading-edge techniques to design and manufacture purpose-built parts and components from raw materials. This costly process ensures the tightest tolerances, smallest door gaps, and highest, most consistent level of quality in each and every safe. The competition simply doesn't stack up.

SPECIALLY DESIGNED BALL-BEARING HARD PLATE

Pendleton's specially designed hard-plate prevents drilling out of the lock and protects the relocking mechanism from tampering.

SOLID 1/4" STEEL TOP AND BOTTOM

Burglars will often turn a safe upside down, exposing a vulnerable area on the bottom of a safe. All Pendleton Safe tops and bottoms are manufactured with solid high-strength, low-alloy steel.

CAM SYSTEM PREVENTS BOLT TAMPERING

All bolts operate on an innovative cam system that prevents tampering. If pushed on, these bolts push back, making it impossible to retract the bolts by force.

REINFORCED DOOR FRAME

The entire door frame of each Pendleton Safe is reinforced with structural steel angle to defend against pry bar attacks. You can rest assured that your valuables are protected by a Pendleton. No one else offers security on our level.

ADJUSTABLE HINGES FOR PRECISE FIT

Hinges are adjustable up, down, left and right for the most precise door fit available.

PRE-DRILLED FLOOR BOLTS

All Pendleton Safes are pre-drilled for floor bolts, adding an extra layer of security and peace of mind.



MACHINED FAIL-SAFE DOOR HANDLES

Pendleton's handles utilize a fail-safe system to prevent forced entry. A pressure-sensitive mechanism causes the handle to shear off if a break-in is attempted preventing further tampering.



EMP-RESISTANT PREMIUM S&G LOCKS

A world leader with 150 years of experience in locking systems for safes and vaults, Sargent and Greenleaf locks meet strict national and international security standards.

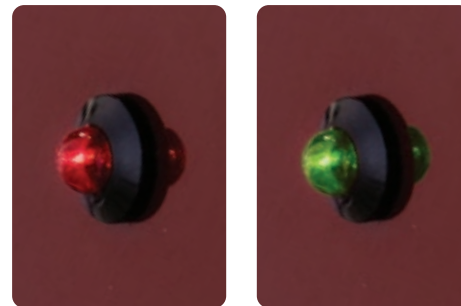

INDICATOR LED LIGHTS

A red LED light (available on any safe with an electronic lock) alerts you when your safe has been left ajar, while the green LED lets you know moisture control features are functioning.



PERSONALIZED NAME PLATES

Pendleton offers personalized, laser-cut, steel name plates.

CHROME ACCENTS

Chrome accents is available on all Pendleton Safes.



REVOLVING EXTERNAL STORAGE SHELF

A revolving external shelf for storing calls, ammo and other gear. Control the rotation easily with the press of a button!

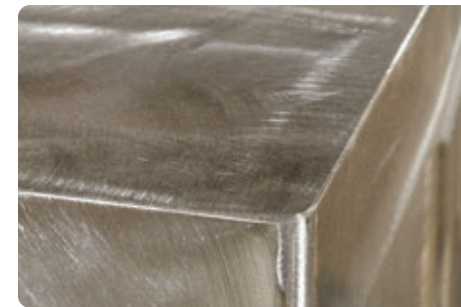

100% FULLY-WELDED SEAMS

Whereas some safe manufacturers use chain welding, Pendleton King Series Safes feature fully-welded and smooth-ground seams for the highest level of security.



PRECISION LASER-CUT DOOR GAPS

All Pendleton door gaps are laser cut to precise tolerances, making Pendleton safes nearly impervious to traditional pry-bar attacks. This exclusive security feature is only available from Pendleton.

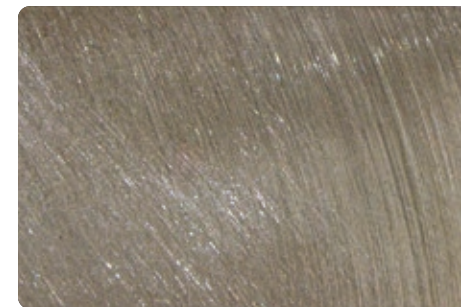

SOLID HIGH-STRENGTH LOW-ALLOY STEEL EXTERIOR

Each Pendleton Safe exterior is built with solid high-strength, low-alloy steel in either 3/16" or 1/4" thickness.



EXCLUSIVE REINFORCED STRIKER BARS

Where the competition's round bolts simply rest behind the face of the door frame, Pendleton's exclusive plate bolts enter into a reinforced steel striker system for superior break-in resistance. Combined with the tightest tolerances and laser-cut door gaps, these safes are virtually impossible to pry open.



PLATE-BOLT DESIGN 5X THE PROTECTION

Pendleton's unique plate-bolt design provides over 50 inches of solid steel locking surface area. That's approximately 5X more break-in resistance compared to the competition's traditional round-bolt design.

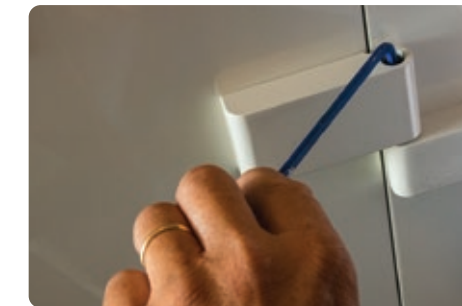

ADJUSTABLE HINGES FOR PRECISE FIT

Pendleton's fully-adjustable hinges are manufactured to the highest security specifications, enabling the most precise door fit available, for unsurpassed pry-bar resistance.



OFFICIAL UL LISTED SECURITY STATUS

Underwriters Laboratories is a global independent safety science company with more than a century of expertise in testing consumer and commercial products for safety and effectiveness.



LUXURY FEATURES AT AFFORDABLE PRICES

Revolution Safes' Revolving Gun Systems are the most functional, innovative and best-value, period. Using Pendleton Revolution Technology® and practical inside-door shelving, Revolution Safes are built to fit, manage and secure a wide range of firearms. With a spin of the turret, any long gun is front and center, helping to prevent unnecessary bangs, scratches and dents. Revolution Safes are the best value in gun-management and security.



STRONGHOLD XL
Pg 30



STRONGHOLD XL RESERVE EDITION
Pg 31



STRONGHOLD XL TACTICAL EDITION
Pg 32



Revolution Technology® is at the heart of each Revolution Safe. A unique circular design with a modular shelving system rotates 360° to bring your guns directly to you. No more bangs, scratches or dents; just fast and easy access to your entire collection.

FEATURES



Locking System
Manual or electronic S&G locks, the finest available.



10 lock bolts
1-1/2" diameter bolts protect all sides from pry attack.



Fail-safe door handle
A fail-safe system that slips under pressure to prevent forced entry.



1200° fire protection
Fully insulated with 2" thick fire liner designed for 1-hour of protection.



HANDGUN SHELVES
Unique inside door shelving accommodates both pistols and revolvers.

DIMENSIONS

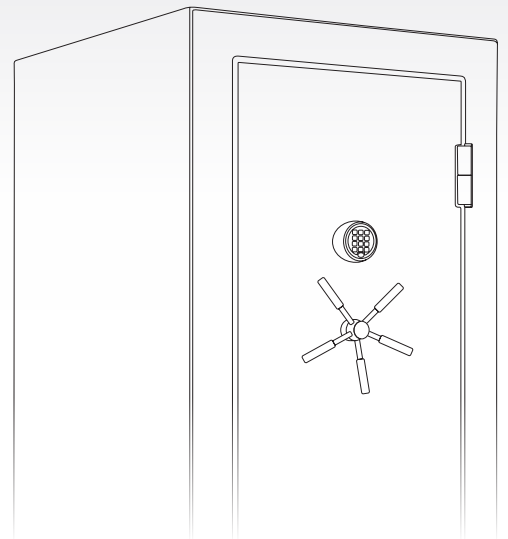

HEIGHT: **72"**
WIDTH: **32.5"**
DEPTH: **36"**
WEIGHT: **1150 LBS.***

* Weight varies based on shelving configuration and options.



OPTIMIZED FOR LONG GUNS

STANDARD FEATURES

- **Automatic lighting**
Featuring over 400 LEDs
- **Moisture control**
Maintenance-free operation
- **Lockbolt indicator***
Shines bright red reminding you to lock the door
* Only available with an electronic lock
- **Electronic lock**
Proven by S&G to withstand military-level EMP attacks
- **15 fixed position handgun storage shelves around inside of door frame**
- **Fixed height, revolving turrets**
10 and 12-gun turrets
- **Holds 4 long guns in back corners**
- **2 large adjustable storage shelves**
24" deep x 29" wide

OPTIONAL FEATURES

- **Adjustable turrets**
Raise or lower turrets for long guns of varying length
- **Manual lock**
- **Solid foam below rifle stocks**
Extra protection for metal or wood bottom stocks
- **Adjustable inner row turret**
Place your shorter lever actions or ARs beside longer guns

STANDARD CAPACITY



LUXURY FEATURES



AFFORDABLE PRICES



OPTIMIZED FOR THE COLLECTOR LONG GUNS, HANDGUNS, PLUS VALUABLES

STANDARD FEATURES

- **Automatic lighting**
Featuring over 400 LEDs
- **Moisture control**
Maintenance-free operation
- **Lockbolt indicator***
Shines bright red reminding you to lock the door
* Only available with an electronic lock
- **Electronic lock**
Proven by S&G to withstand military-level EMP attacks
- **15 fixed position handgun storage shelves around inside of door frame**
- **Adjustable package**
Raise or lower turrets and first shelving row to accommodate your barrel lengths
- **10 and 12-gun turrets**
- **Revolving long gun / combo handgun shelves**
6 handguns per shelf, 12 total
- **Revolving storage for valuables**
• 28.5" deep
• All-steel construction

OPTIONAL FEATURES

- **Capacity for up to 80 handguns**
without reducing long gun storage capacity
- **Manual lock**
- **Solid foam below rifle stocks**
Extra protection for metal or wood bottom stocks
- **Adjustable inner row turret**
Place your shorter lever actions or ARs beside longer guns

STANDARD CAPACITY



LUXURY FEATURES



AFFORDABLE PRICES

OPTIMIZED FOR TACTICAL RIFLES



Shown with optional features

STANDARD FEATURES

- **Automatic lighting**
Featuring over 400 LEDs
- **Moisture control**
Maintenance-free operation
- **Lockbolt indicator***
Shines bright red reminding you to lock the door
* Only available with an electronic lock
- **Electronic lock**
Proven by S&G to withstand military-level EMP attacks
- **15 fixed position handgun storage shelves around inside of door frame**
- **Turret configurations**
 - 10-gun turret
 - Tactical base turret
 - Tactical turret
- **Fully adjustable**
Independently raise or lower ANY shelf on the shaft - Tactical rifle placement is no longer a challenge
- **3 revolving shelves**
 - All-steel construction
 - Long gun / combo handgun shelf
 - Two storage shelves

OPTIONAL FEATURES

- **Capacity for up to 54 handguns**
without reducing long gun storage capacity
- **Adjustable SBR and bull pup inner row turret**
- **Manual lock**
- **Solid foam below rifle stocks**
Extra protection for metal or wood bottom stocks

STANDARD CAPACITY



LUXURY FEATURES



AFFORDABLE PRICES



NOT QUITE RIGHT? BUILD YOUR OWN!

PICK YOUR SHELVES



Long gun / combo handgun shelf



Combo handgun shelf



Storage shelf

PICK YOUR TURRETS



Tactical base turret



10-gun turret



12-gun turret



Tactical turret



10-AR turret

PICK YOUR ATTACHMENTS



Shelf guard



Adjustable 6-AR turret



Adjustable 5 long gun turret



Adjustable dual AR turret



Adjustable single gun turret

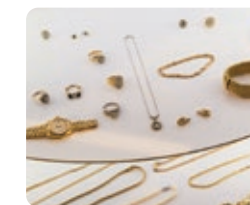

JEWELRY CONFIGURATION



HALF SHELIVING WITH GUARD

Revolution Safes are completely customizable. Build your own safe with different turret systems and shelving options to provide the most functional safe for your valuables. You can find all of Revolution's shelving, turret, and attachment options on this page so you can start building the perfect configuration for your collection.

ST
STRONGHOLD

ORDER FACTORY DIRECT

www.RevolutionSafes.com or 770-466-6181

DT
STRONGHOLD

REVOLUTION[®]
SAFE COMPANY



Shown with optional features



Shown with optional features

HEIGHT: 59" WIDTH: 28.5" DEPTH: 31" WEIGHT: 780 LBS.*

* Weight varies based on shelving configuration and options.

HEIGHT: 59" WIDTH: 53.5" DEPTH: 31" WEIGHT: 1250 LBS.*

* Weight varies based on shelving configuration and options.



Locking System

Manual or electronic S&G locks, the finest available.



10 lock bolts

1-1/2" diameter bolts protect all sides from pry attack.



Fail-safe door handle

A fail-safe system that slips under pressure to prevent forced entry.



1200° fire protection

Fully insulated with 2" thick fire liner designed for 1-hour of protection.

STANDARD FEATURES

- **Electronic lock**
Proven by S&G to withstand military-level EMP attacks
- **Revolving long gun management**
Turrets spin easily by hand
- **Adjustable storage shelf**

OPTIONAL FEATURES

- **Automatic lighting**
Featuring over 400 LEDs
- **Moisture control**
Maintenance-free operation
- **Adjustable turrets**
Raise or lower turrets for long guns of varying length
- **Manual lock**
- **Adjustable inner row turret**
Place your shorter lever actions or ARs beside longer guns
- **Lockbolt indicator***
Shines bright red reminding you to lock the door
* Only available with an electronic lock
- **Handgun shelving**

CAPACITY



UP TO 12 HANDGUNS
(OPTIONAL)

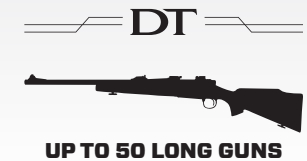

UP TO 21 HANDGUNS
(OPTIONAL)



HEAVY DUTY TARGETS

The all steel construction of the HD line features AR500 plate on both the impact and shield surfaces. Our fully-revolving, auto-resetting targets are built to handle constant punishment. This line is ideal for commercial ranges or shooters with a dedicated space for permanent targets. Elevate your experience with rugged HD steel targets that spin when hit. These reactive targets provide the instant feedback you (or your spotter) have been looking for.

HEAVY DUTY MULTI TARGET

Outfit your range with a complete course of fire using one target.

12 FT. WIDE

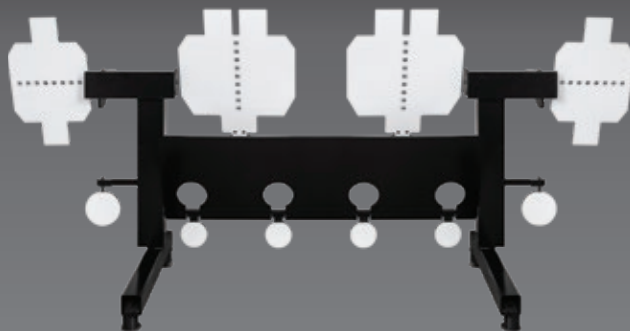

- REACTIVE
- AUTO RESET
- AUDIBLE FEEDBACK

VIDEO DEMONSTRATION
RevolutionTargets.com/HDMULTI

RECOMMENDED USE



HEAVY DUTY PLATE RACK



"This is the most efficient plate rack I have ever used. No reset makes it the best!"

KC Eusebio,
World Champion Pistol Shooter



- REACTIVE
- AUTO RESET

VIDEO DEMONSTRATION
RevolutionTargets.com/HDRACK

RECOMMENDED USE



HEAVY DUTY GONG



GONG DIAMETERS

36"

30"

24"

CUSTOM DIAMETERS AVAILABLE

- AUDIBLE FEEDBACK

VIDEO DEMONSTRATION
RevolutionTargets.com/HDGONG

RECOMMENDED USE



HEAVY DUTY DUELING TREE

Compete head to head with friends. Handicap using independent difficulty adjustment.

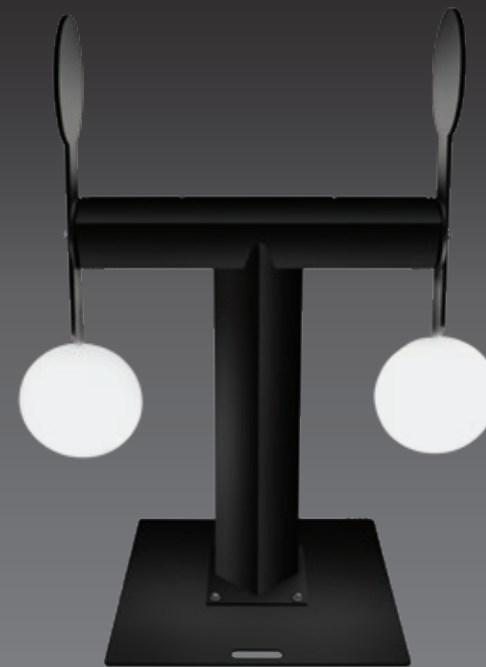

- REACTIVE
- AUTO RESET
- HEAD TO HEAD

VIDEO DEMONSTRATION
RevolutionTargets.com/HDTREE

RECOMMENDED USE



HEAVY DUTY DOUBLE TORSO

Revolving hit indication gives easy visual confirmation from long range with a rifle or up close with a handgun.

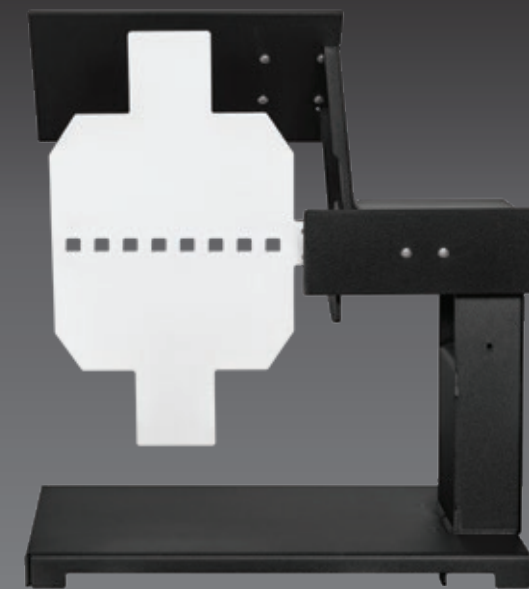

- REACTIVE
- AUTO RESET

VIDEO DEMONSTRATION
RevolutionTargets.com/HDTORSO

RECOMMENDED USE



HEAVY DUTY HOSTAGE TARGET

Excellent training tool - reactive torso spins - loads of fun.

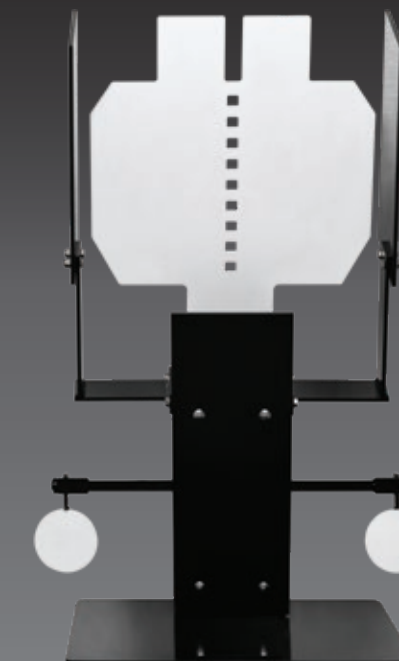

- REACTIVE
- AUTO RESET
- AUDIBLE FEEDBACK

VIDEO DEMONSTRATION
RevolutionTargets.com/HDHOSTAGE

RECOMMENDED USE



PORTABLE TARGETS

Our portable line enjoys all the high-end features of the HD line but can be moved with less effort so your range can be quickly modified for a new experience. Designed so a single individual can transport with ease. These high-quality targets are simply engineered to be lighter — they easily rotate when hit to offer the reactive feedback you need.

PORTABLE PLATE TARGETS



"This is quite simply, the best plate rack in the world."
Michael Bane - Shooting Gallery

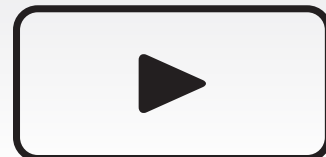

WATCH THIS VIDEO!

MICHAEL BANE SHOWS YOU THE PORTABLE PLATE RACK, WHAT MAKES IT SPECIAL, AND WHAT HE THINKS ABOUT IT.

RevolutionTargets.com/MBPPR

RECOMMENDED USE



PORTABLE DUELING TREE

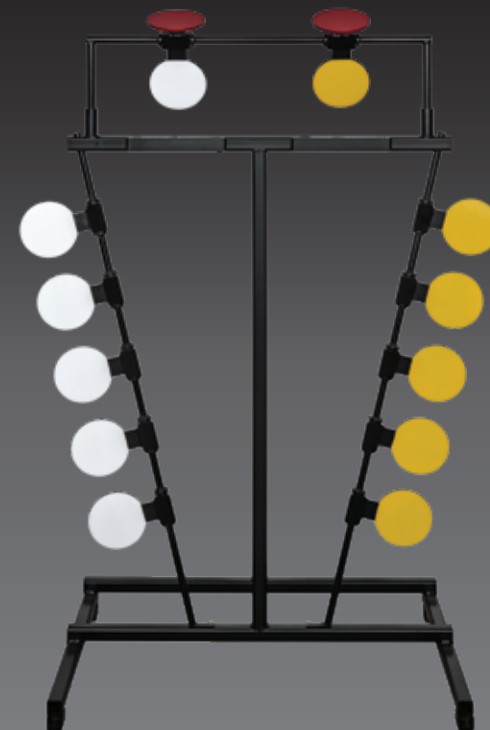

VIDEO DEMONSTRATION
RevolutionTargets.com/PDT

RECOMMENDED USE

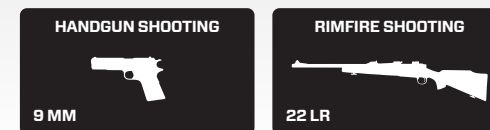

PORTABLE LONG RANGE TORSO

Normally out of sight, the long range indicator rolls into view and flashes red when the hit zone is struck.

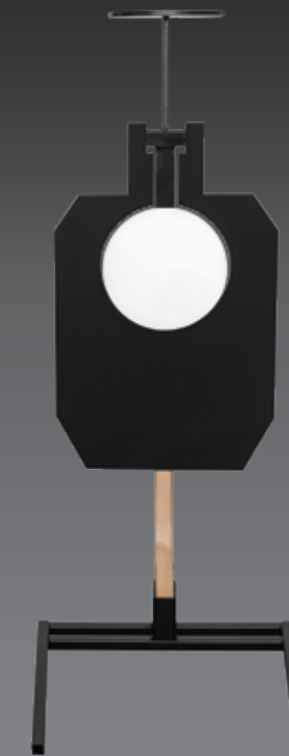

On Target Magazine
Editor's Choice
Award Winner



LONG RANGE INDICATOR



VIDEO DEMONSTRATION
RevolutionTargets.com/PLRT

RECOMMENDED USE



PRACTICE THE PRECISION RIFLE SPORT IN YOUR OWN BACKYARD

COMPACT TARGETS
EASY - REACTIVE - RELIABLE - FUN

Range set up and tear down - YOU HATE IT, WE HATE IT, EVERYBODY HATES IT. Good news, Revolution's Compact line makes it easy: separate stands not required, plus carry several at once. When hit, they spin! The visual is fun and makes spotting simple - plus - the reactive feedback builds shooter confidence and skill. The best feature? No need to go downrange and reset targets! It's automatic. Use Revolution Compact Targets and enjoy more time at the shooting line.

COMPACT PRECISION RIFLE TARGETS

Challenge yourself and hone your skill. Improve your accuracy using 2, 3, and 4 moa precision targets to test your limits.

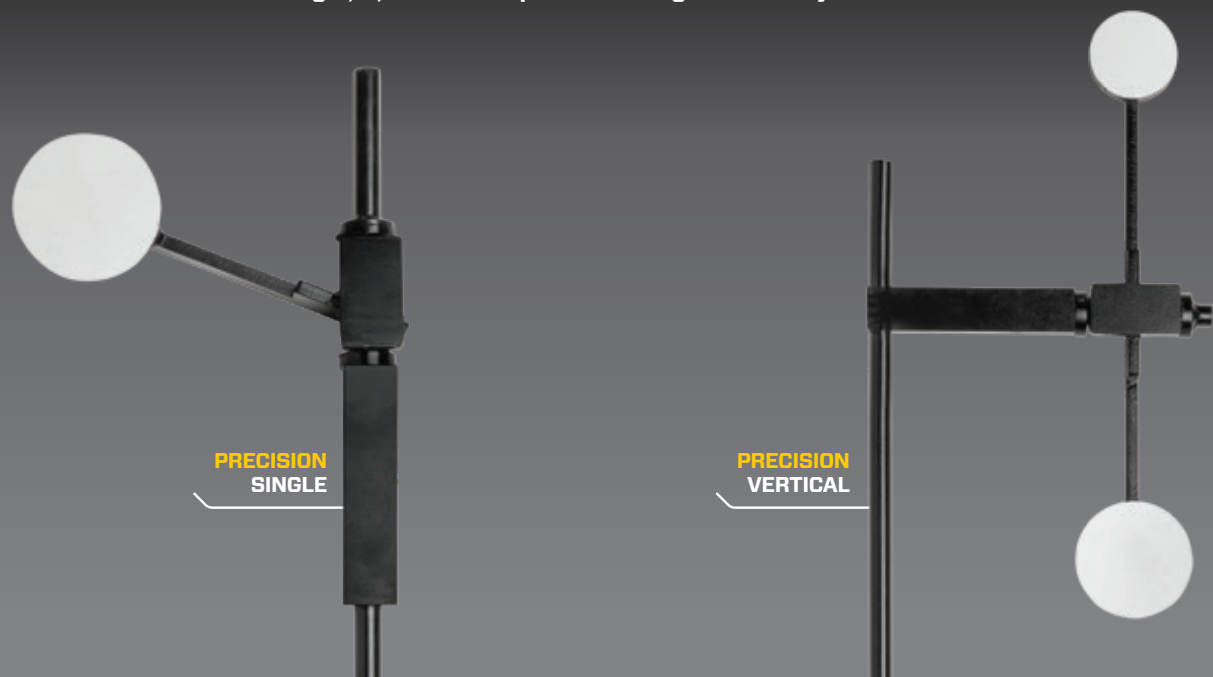

PRECISION SINGLE

PRECISION VERTICAL

-  HARDENED AR500 SHOOTING SURFACES
-  REACTIVE
-  AUTO RESET

COMPACT SPEED TARGETS

Shooting for fun? For competition? These fit any purpose.



SPEED SINGLE

SPEED VERTICAL

SPEED HORIZONTAL

-  REACTIVE
-  AUTO RESET



VIDEO DEMONSTRATION
RevolutionTargets.com/CPT

PRECISION RIFLE TARGETS

Use our Compact Precision Rifle Targets to practice shooting long range distances at 100 yards. Available in 2, 3 and 4 MOA versions.

They give great hit indication PLUS you don't have to go downrange to reset them.

RECOMMENDED USE



VIDEO DEMONSTRATION
RevolutionTargets.com/CST

SPEED TARGETS

Built tough and designed for long life to fit any budget. Grease fittings ensure reliable operation, even when left outside in the weather.

RECOMMENDED USE

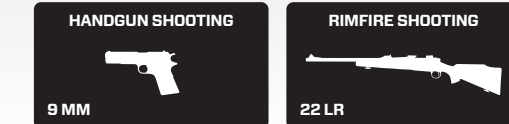

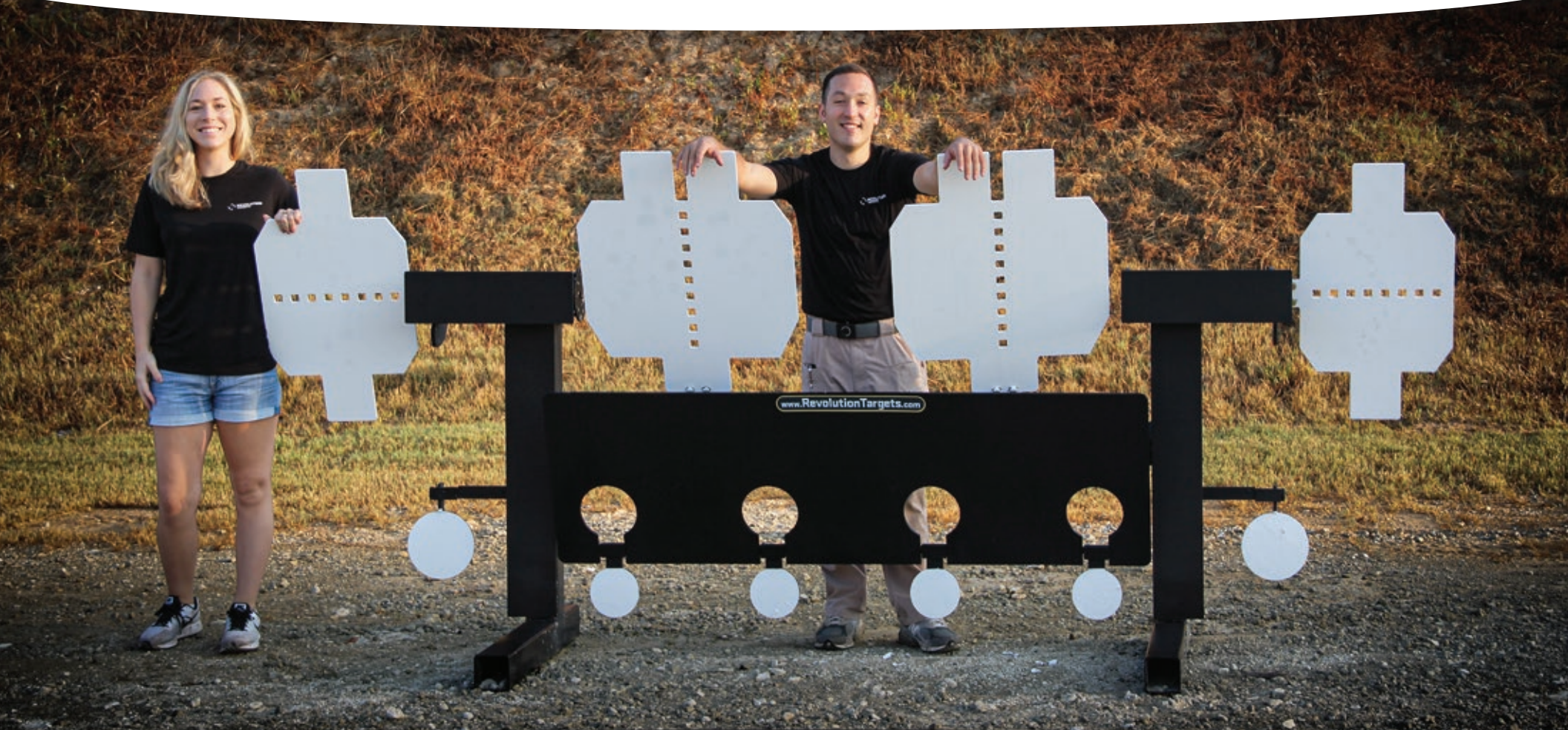

@pendletonsafes @pendletonsafes @pendletonsafes

www.PendletonSafes.com

@revolutionsafecompany @revolutionsafecompany @revolutionsafes

www.RevolutionSafes.com

@revolutiontargets @revolutiontargets @revolutiontargets

www.RevolutionTargets.com

G&S SECURITY INCORPORATED
P.O. Box 2506, Loganville, GA 30052 • 770-466-6181